



# Instruction Manual on

# EDFC

## Electronic Damping Force Controller

### Preface

Thank you for purchasing EDFC.  
EDFC is the electronic damping force controller which enables to control the damping force from the driver's seat.  
You can control the damping force to meet the various situations and easily set the suspension as you like. Please enjoy and feel the changes of the damping force in the driver's seat.



### Contents

	(Page)
Preface, Contents, Before reading this Manual.....	Front Page
Cautions on handling.....	1·2
Specifications on parts and the items contained.....	3
Nomenclature and function of each part .....	4
Installation .....	5·6·7
EDFC Harness Tangle-Proof Kit.....	8
Operation.....	9·10
Trouble-shooting,Important Notice and the customer service.....	11

### Before reading this Manual

In order to install and use EDFC in good conditions, you are requested to carefully read this Manual to acquire full understandings of the constructions and functions. Please keep this Manual in the car which is equipped with EDFC and when you transfer such a car please transfer it with this Manual.

#### 《Meaning of the abbreviation and symbol in this Manual》

-  **WARNING** Should this indication be neglected and improper handling attempted, such critical risks, which could result in fatal accidents, death, serious physical injuries or serious material damages are impending.
-  **CAUTION** Should this indication be neglected and improper handling attempted, there are possibilities of physical injuries or material damages.
- CONFIRMATION** Matter to be confirmed      **REF** Reference       Recommended tightening torque

TEIN is not liable for fatal accidents, injuries, material damages, etc. caused by disregarding the contents in this manual.

Please note that TEIN shall not assume all the costs for removal and installation, relative labor, transportation, repairing a car and also the time loss.

- Publishing the portion or all of contents of this manual without TEIN' prior written consent is prohibited by the Copyright Act.

## Caution on handling



- It is recommended that EDFC is installed by a qualified auto mechanic. Since you will take responsibility for the installation, be sure to install it after carefully reading and fully understanding this Instruction Manual. TEIN recommends the user who is not so experienced in overhaul of a vehicle to install EDFC under a qualified person to prevent breakdown or accident.
- Install EDFC after the engine, brake and the parts around it become cold completely. Immediately after driving the engine or the parts around it such as piping, brake, etc. have high temperature and there are possibilities of serious injuries such as burn, etc.
- Carefully study in advance where and how to install EDFC to prevent it from coming off or interfering with driving.
- Before lifting up or jacking up the automobile for installation never fail to use a stopper or rigid rack, etc.
- Be sure that there is nothing under the driver's seat. If there is anything such as an empty can or a tool, it is caught under a brake pedal and causes the serious danger such as disturbing brake operation.
- Never operate the controller while driving. There is a possibility of causing an unpredicted accident resulting in an injury or death.



- As EDFC is precisely made never drop or give a shock to it. If a strong shock is given to it immediately stop using it.
- For installing EDFC it is necessary to process or remove interior parts or electronic apparatus. TEIN can take no responsibility for the damage of such products and carefully install it.
- Before wiring be sure to extract a key from a key cylinder and remove the cable from the minus terminal of a battery in order to prevent short-circuiting during the work.
- Never connect the wire conversely or mistake the connection of the wire in order to prevent short-circuiting. If it short-circuits other electronic apparatus may be also damaged.
- Never install the control box at the following places to prevent deformation of the case or malfunction.
  - Humid or dusty place
  - Any place with high temperature due to being exposed to sunlight directly or warm air from the heater.
- Do not damage, press or pull the motor cable to prevent disconnection or electric leakage.
- Never insert a minus driver or other products into a connector to prevent deformation or impairing water proof.
- Never use an impact wrench for installing the parts of the shock absorber to prevent the inside nut from loosening. If the nut comes off the piston rod jumps out vigorously by the pressure of the inside gas, which is very dangerous.
- Be sure not to damage the thread of the shock absorber piston rod or oscillating parts by directly handling with a tool, giving a shock, dropping or hitting unnecessarily. If the piston rod is damaged, the oil seal is flawed and it becomes the cause of the oil leakage and malfunction.
- Never disassemble EDFC. If disassembled, it may be damaged.
- Do not modify EDFC. It may become the cause of performance decrement or breakage.
- Before installing confirm if there is no burr on each part.
- Be sure to tighten each part according to the specified torque in this manual.
- Never drive radically just after installing EDFC.
- Daily inspection is driver's responsibility. After installing EDFC inspect it periodically and confirm if every part is firmly connected and clean it. If it is not used for a long period (about one month) confirm if it operates normally before using it.
- When washing an engine room with steam be sure not to wet the motor. It may cause the damage. If water or oil enters the motor it may cause the damage and stop using it immediately.
- When the motor is installed in a car trunk be sure that the baggage does not damage it while driving.
- Never bring a magnet card to the motor. As the motor uses the magnet it may damage the card.
- Don't use a communication machine such as cellular phone near the controller of our product. It causes faulty operation.
- Pull out the connector on the motor side and the intermediate cable surely, when you adjust car height with the shock absorber. It causes the breakage of the cable when height adjustment is done with a connector connected

## Caution on handling



### 【Threadlocker and Grease】

- Never attach them to the skin for the skin may be influenced by them depending on the constitution.
- When they attached to the skin, immediately wipe off and wash with soap.
- When the eyes become contaminated, never wipe them and immediately wash the eyes with water. Then, receive medical treatment.
- When they soak in the clothing they cannot be removed.
- Keep them in the place where children do not reach.
- Never use them for the applications except the ones stipulated in this manual.
- Never use near fire.
- Keep them in a place which is not exposed to direct sunlight.
- Be careful not to put them into the mouth.

#### Description of Threadlocker

Name of Article: anaerobic adhesive agent  
Application: Screw slack prevention  
Component: Synthetic resin (100%)  
Net volume: 4ml

### CONFIRMATION

- Before starting the work confirm if all parts are contained according to the list of the parts.
- If the cable is removed from the minus terminal of a battery the memory contents of electronic apparatus having the memory functions such as a clock, a car audio, etc. may be deleted. So, before starting the work confirm of each function from the manual and, if necessary, re-set after finishing the work.
- Use neutral detergent and remove the dust and oil of a place where a double-stick tape is stuck.
- When you with tapping screws, be careful not to damage the car body with the projected screw points.
- Clean EDFC with the dry cloth and if it is dirty, wipe with firmly wrung cloth. Never use benzene or thinner which may deteriorate the paint of the case.
- EDFC and this manual may be changed for improvement without notice.
- For further details and any questions contact our customer service representative.

## MEMO

## Specifications on EDFC

- Name of Product : EDFC (Electronic Damping Force Controller)
- Application : Controlling the damping force of the shock absorber in the driver's seat
- Vehicle to be installed : The vehicles specified by TEIN and also the vehicles equipped with shock absorbers specified by TEIN (DC12V with minus ground).
- Conditions : Operation while a vehicle stops
- Power consumption : 15mA at the time of power supply for accessory OFF,  
2.8A at the time of the accessory power supply ON (at the time of motor rotation)  
1.2A at the time of the accessory power supply ON (at the time of motor stop)

## List of Contents

Description	Number of Kit	Part Number	Unit price (MSRP)
Controller	1	—	—
Motor with a rubber cover (M10)	See the following table	EDC01-F1135-1	\$ 52.00
Motor with a rubber cover (M12)	See the following table	EDC01-F1135-2	\$ 52.00
Motor with a rubber cover (M14)	See the following table	EDC01-F1135-3	\$ 52.00
Rubber cover only	—	EDC01-F1656	\$ 5.00
Power Supply Cable( 2.0 m )	1	EDC01-F1320	\$ 8.00
Ft Cable( 1.0 m )	1	EDC01-F1321	\$ 7.00
Rr Cable( 1.0 m )	1	EDC01-F1322	\$ 7.00
Intermediate cable FR( 2.5 m )	1	EDC01-F1323	\$ 10.00
Intermediate cable FL( 2.5 m )	1	EDC01-F1324	\$ 10.00
Intermediate cable RR( 4.0 m )	1	EDC01-F1346	\$ 11.00
Intermediate cable RL( 4.0 m )	1	EDC01-F1347	\$ 11.00
Bracket for Control box	1	EDC02-F1136	\$ 8.00
Tapping screw	2		
Velcro	2		
Branch connector	3		
Tie lap	10		
Double-stick tape(50 × 30)	2		
Double-stick tape(75 × 18)	1		
8mm spanner	1	SST01-F1126	\$ 5.00
Hexagon socket set screw	4	SAP44-F1127	\$ 3.00
3mm Hex key	1	—	—
Grease	1	—	—
Threadlocker	1	—	—
Handling Manual	1	—	—
Container box	1	—	—
EDFC Harness Tangle-Proof Kit (Only for EDKU3-XX)	1 ea.	EDC02-H3261/J2337	—

<Quantity of motors with rubber covers in each model>

KIT No.	Q'ty of Motor (M10)	Q'ty of Motor (M12)	Q'ty of Motor (M14)
EDKU1-10100	4	—	—
EDKU1-10120	2	2	—
EDKU1 (U3)-10140	2	—	2
EDKU1-12120	—	4	—
EDKU1 (U3)-12140	—	2	2
EDKU1 (U3)-14140	—	—	4

※Part numbers and the prices may be changed without notice, which please understand

## Nomenclature and function of each part

### Front face

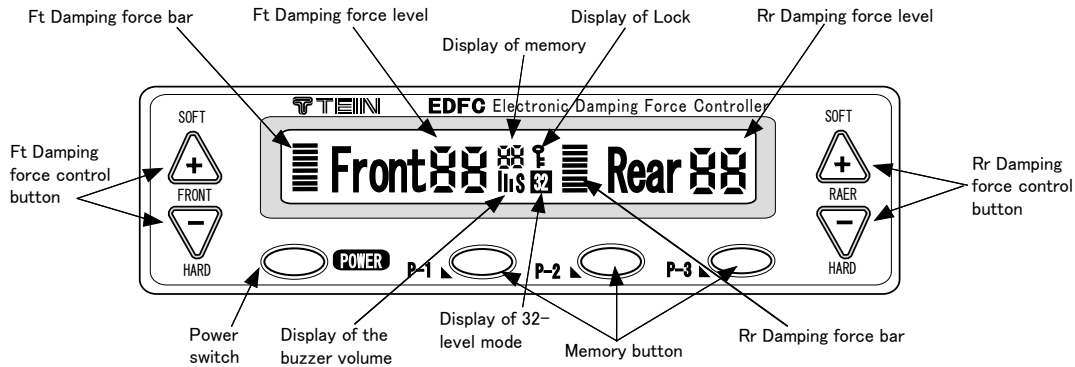

- Power switch.....For turning on or off the power supply to EDFC
- Ft Damping force control + button .....For reducing Ft damping force (soft)
- Ft Damping force control - button .....For increasing Ft damping force (hard)
- Rr Damping force control + button .....For reducing Rr damping force (soft)
- Rr Damping force control - button .....For increasing Rr damping force (hard)
- Memory button (P-1, P-2 and P-3).....For storing and recalling the memory contents of desired settings.
- Display of LCD
  - Ft Damping force level ..... Showing Ft damping force level
  - Ft Damping force bar ..... Showing Ft damping force bar
  - Rr Damping force level ..... Showing Rr damping force level
  - Rr Damping force bar ..... Showing Rr damping force bar
  - Display of memory ..... Showing the memory contents
  - Display of 32-level mode ..... Showing 32 at 32-level mode
  - Display of lock mark ..... Showing the mark of KEY
  - Display of the buzzer volume ..... Showing the level of the buzzer volume

### Back face

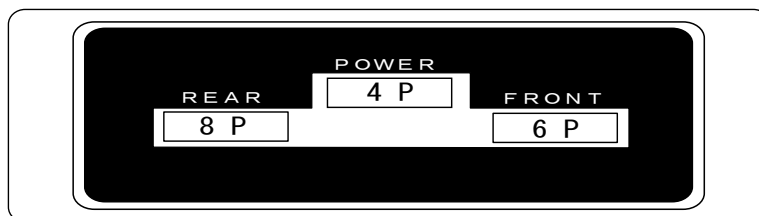

- 4P Connector.....For connecting to 4P connector of power cable
- 6P Connector.....For connecting to 6P connector of Ft cable
- 8P Connector.....For connecting to 8P connector of Rr cable

## Installation

The methods of installation are mentioned hereunder in order of the motor, controller and wiring

### Motor

Install the motor after assembling the shock absorber and the spring upper mount and then screw the top nut firmly by the designated torque because it is difficult to screw it after installing the motor. If it is difficult to install the motor to the car on which the shock absorbers are equipped we recommend installing the motor after detaching the shock absorber. In this case, be careful not to give a shock to the motor.

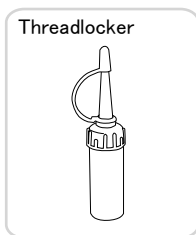
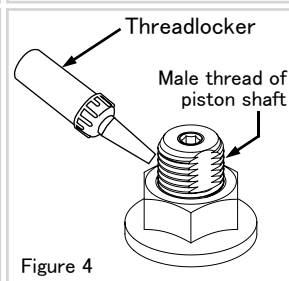
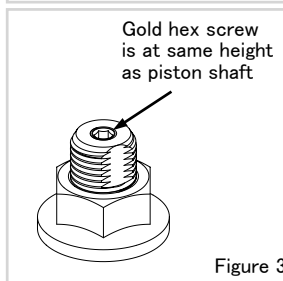
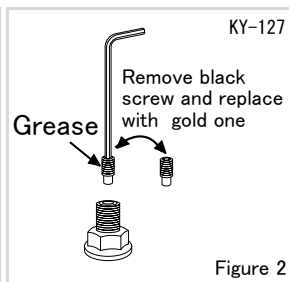
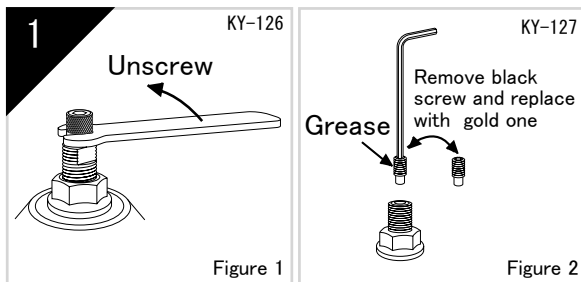

1) Detach and remove the silver click assembly located at the top of the piston shaft using the 8mm black spanner wrench contained in the kit. (Figure 1)

2) Using the provided silver hex key, unscrew and remove the black hex screw located inside the piston shaft. (Figure 2)

⚠ CAUTION Keep the removed click & black-colored hexagon socket set screw for reuse.

⚠ CAUTION Never invert (turn upside down) the shock absorber after removing the hexagon socket set screw as the internal parts may come off.

3) Apply the grease contained in KIT to the threads on the gold hex screw contained in the KIT. (Figure 2)

4) Carefully use the hex key to screw in the gold hex screw in place of the previously removed black hex screw. Screw in GOLD hex screw until the top of the hex screw is flush with the top of the piston shaft. (Figure 3)

5) Remove the black rubber cap on the motor.

6) Check thread size on piston shaft and match to motor with same thread size. (Some kits have different sized front EDFC motors than rear EDFC motors)

REF The size of the motor can be distinguished by the distinction groove outside the shaft attachment part.  
(M10 : without groove M12 : One groove M14 : Two grooves)

7) Shake the thread locker bottle well (about ten times) before each use, as its ingredients might be separated.

8) Apply the thread locker (green liquid) appropriately to the male thread on the piston shaft. (Figure 4)

⚠ CAUTION Never apply the threadlocker to the female thread of the hexagon socket set screw as it would not be screwed.

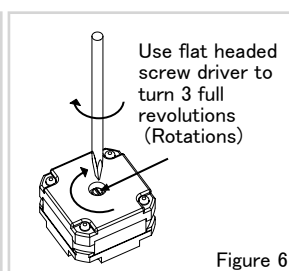
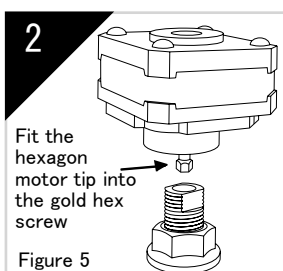

1) Fit the hexagon tip of the EDFC motor into the gold hex screw. (Figure 5)

⚠ CAUTION As the motor shaft and other parts are precisely made, screw them by hand at the installation. Be sure not to impose a stress or give a shock to them.

2) Hold the motor by hand and use a flat head screwdriver to turn the slotted screw located on the top center section of the motor 3 full revolutions in the clockwise direction. (Figure 6)

3) GENTLY screw the motor in the clockwise direction onto the piston shaft until it stops. (Figure 7)

4) Again, use a flat-headed screwdriver to screw the slot 2 full revolutions.

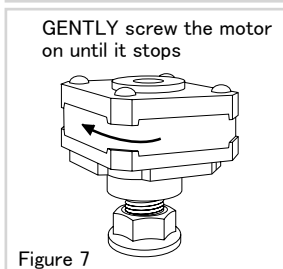

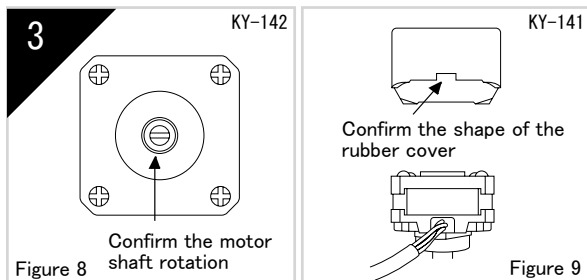

1) Now fully screw the motor with the designated torque (hand tight).

The Designated Torque: 3 N•m

**CAUTION** Be careful not to impose stress to the black-colored part (core part) on the side of the motor with tools, etc. If a stress is imposed the motor may be broken. Also, never screw the motor with the torque of over 12Nm or further turn it over 45 degrees from the position of screwing in. Otherwise, the motor may be damaged.

2) Confirm that the motor shaft turns by using the flat-head screwdriver to turn the slot counterclockwise 1 revolution and then back clockwise 1 revolution.(Figure 8)

**CAUTION** Confirm if the motor shaft rotate smoothly after fully screwing it. If not, some parts may be broken or those parts are not correctly assembled. In this case, disassemble them after confirming all parts are not broken.

3) Re-attach the black rubber cap onto the EDFC motor. (Figure 9)

**CAUTION** Put the rubber cover back on the motor, and also the position where the wires are connected.

**CAUTION** Be careful to confirm if the rubber cover is attached correctly. Otherwise, dust or moisture entering into the cover may shorten the lifetime of the motor or cause the trouble.

## Control Box

Installation by the exclusive bracket and tapping screws

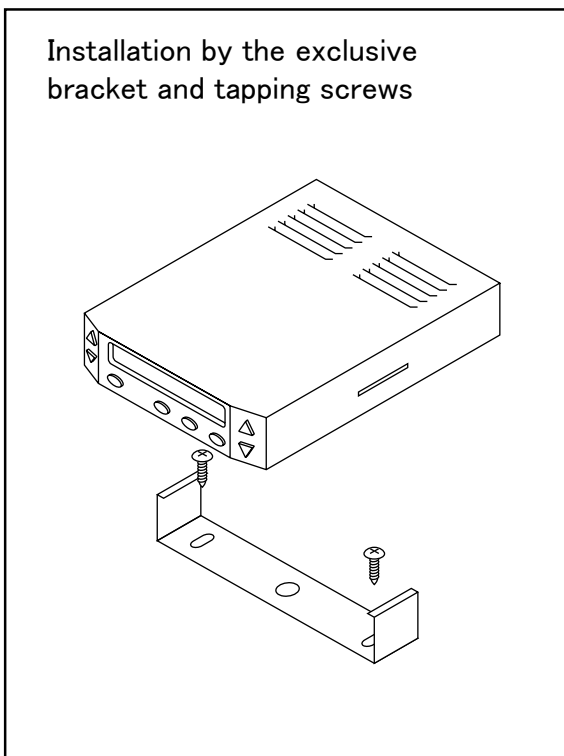

Control Box can be installed by the following three methods and you can select the suitable method for the place for installation.

1. By the exclusive bracket and tapping screws
2. By Velcro
3. By the double-stick tape

**WARNING** Before installing it carefully examine where and how to install it as it would not fall off or never interfere with driving. Installation by a wrong method and/or at an inadequate place is very dangerous, as it would become the causes of vehicle damage and the interference of driving.

**CAUTION** Never install the communication instrument to the controller. It may be error operation

Never install the communication instrument such as cellular phone near the controller. It causes error operation

Never install it at the places as follows because installation at those places would become the cause of the malfunction.

- Humid or dusty place
- Any place with high temperature due to being exposed to sunlight directly or warm air from the heater.

**REF** For installation of it by the double-stick tape, wipe off dirt or oil on the place well using neutral detergent.

## Wiring

The wiring diagram is shown in the left. In order to prevent the unexpected short-circuit start the wiring work always after removing the cable from the minus terminal of a battery and connect it after finishing all the work. When electricity begins to flow a buzzer sounds and you can confirm it.

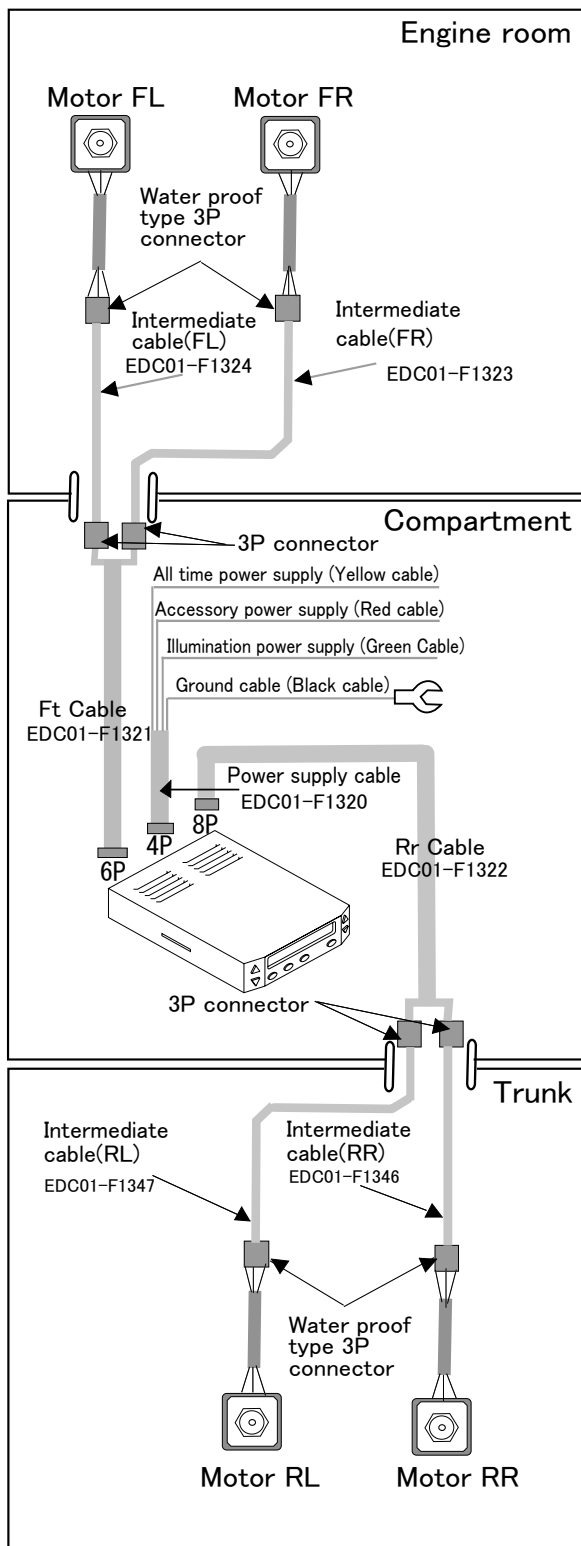

### 1. Power supply cable (The cable with 4P connector)

- All time power supply (Yellow cable)  
Connect using a branch connector from the all time power supply.
- Accessory power supply (Red cable)  
Connect using a branch connector from the accessory power supply having sufficient electric capacity such as a cigarette lighter.
- Illumination power supply (Green cable)  
Connect using a branch connector from the illumination power supply
- Ground cable (Black cable)  
Firmly connect to the plated metal part and avoid connecting the painted metal part.

**CAUTION** If the red cable is connected to the accessory power supply not having sufficient electric capacity sufficient electric power to operate a motor would not be obtained and also it would have a bad influence on the other electric car components.

### 2. Intermediate cables for Ft and Rr

- Firmly connect Ft cable connector (6P) and Rr cable connector(8P) to the control box
- Wire the intermediate cables to the compartment from an engine room and a trunk.
- Firmly connect Ft cable and Rr cable to the intermediate cables according to the labels.
- Fix the cable of excessive length by a tie lap.

**CAUTION** Place the connectors for connecting the intermediate cable to Ft cable and Rr cable in a compartment for they are not moisture proof types. If they are wet, it would become the causes of short-circuit or breakage of the controller.  
For wiring from an engine room or a trunk, be careful not to damage the cable at a square of the car body.

**REF** If an intermediate cable is short other cable can be used. But in this case be sure to correctly connect each cable according to the labels of Ft cable and Rr cable. Wiring mistake causes the problems such as operating a different motor or showing an error mark at the different position on the display.

### 3. Connecting to the motor

- Firmly connect the connector of the motor cable to that of an intermediate cable.
- Fix the connector by the tie lap contained in KIT after loosening the cable a little.

**CAUTION** Be careful to loosen the motor cable a little in order not to be pulled by the motion of the suspension. Especially as for Ft strut type vehicle the cable must be loosened enough not to be pulled and for preventing the cable from a short-circuit or disconnection in consideration of the time when the steering wheel is turned. Also, periodical inspections are required. When the ride height is adjusted by shock absorber, pull out the connector on the motor side and the intermediate cable. It causes the breakage of the cable when height adjustment is done with a connector connected.



## ● Usage Conditions

Installation of this product is voluntary.

This product prevents the wiring from coiling around when adjusting the ride height upon set-up, without removing the wiring itself.

Depending upon driving conditions and/or settings, the EDFC motor might rotate in one direction. If let alone, the wiring might get tangled up with piston rod and, consequently, might be broken/disconnected.

It usually does not create any problem if the wiring is unwound whenever the tangling is found or upon periodic inspections, however in rare cases the incidence is quite high enough to cause breakage/disconnection in between routine maintenance.

If tangling of the wiring occurs within a few days of EDFC installation, install this product to prevent future occurrence.

Part #7  
Camber Adjusting Bolt  
(Low Type)  
SAP37-J2131

Part #8 Spring Washer  
SAP40-J2145

Part #9 Plain Washer  
SAP40-J2146

Pillowball Uppermount

Pillow Ball Case

Part #6 Bolt Collar  
PMP04-J2129

Part #1 (Stopper #1)  
PMP04-J2129

Part #4 Bolt (short) or  
Part #5 Bolt (long)  
SAP37-J2130 or  
SAP37-H3080

Part #3 (Collar)  
PMP04-H0364

Part #2 (Stopper #2)  
SAP09-H0364

Upper S/P Seat

Piston Rod

**【Components】**

- 1) Part #1 (Stopper #1) x2pc.
- 2) Part #2 (Stopper #2) x2pc.
- 3) Part #3 (Collar) x2pc.
- 4) Part #4 Bolt (short) x4pc.
- 5) Part #5 Bolt (long) x4pc.
- 6) Part #6 Bolt Collar x4pc.
- 7) Part #7 Camber Adjusting Bolt (Low Type) x8pc.
- 8) Part #8 Spring Washer x8pc.
- 9) Part #9 Plain Washer x8pc.

**【Installation Procedure】**

- 1) Install 'Part #1 (Stopper #1)' using bolts included in the kit.
  - \*There are two rows of four screw holes on the reverse side of Pillowball Uppermount. Use two holes at the end of each row.
  - \*If the above is not available, move the camber adjusting bolts to the ones inside.
  - \*Use 'Part #5 (Bolt <long>)' and 'Part #6 (Bolt Collar)' for the kit with the pillow ball case 24.5mm high (refer to the figure 1 shown below).
  - \*Also, for the kit with the pillow ball case 24.5mm high, EDFC motor might interfere with the camber adjusting bolt, depending on the camber angle setting. In that case, use 'Part #7 (Camber Adjusting Bolt <low type>)', 'Part #8 (Spring Washer)' and 'Part #9 (Plain Washer)' to avoid interference.
- 2) Mount 'Part #2 (Stopper #2)' to Upper Spring Seat.
  - \*Fit protruding part 'A' to one of the vertical slots on the side of Upper Spring Seat.
  - \*Insert upper protruding part of Upper Spring Seat through the hole.
- 3) Mount Upper Spring Seat, assembled in step 2) above, to Piston Rod.
  - \*Align the slot on Piston Rod with the one on Upper Spring Seat.
- 4) Insert 'Part #3 (Collar)'.
  - \*Place the side with smaller inner diameter on top.
- 5) Mount Pillowball Uppermount.
  - \*Fit the protruding part 'B' of 'Part #2 (Stopper #2)' in between parts 'C' (not facing the bolts) of 'Part #1 (Stopper #1)'.
- 6) Tighten Pillow Nut.

- After confirming that all wiring work is finished and all parts are equipped, turn on the accessory power supply.

### 1. How to turn on the system

- By pushing the power supply button for two seconds the power supply of EDFC is turned on and the zero return mode is performed. With this operation the motors of Ft and Rr rotate and the damping force control mechanism of each shock absorber is in a totally close state (0 level). The state is display on LCD. (The damping force is in the hardest state).
- By pushing the power supply button for two seconds the power supply of EDFC is turned off.

 **CAUTION** If the power supplies of EDFC and accessory are on electricity flows on a motor and the damping force level would not be changed even if a car swings. Keep in mind that the damping force level may be changed by swinging of a car if driving with the power supply of EDFC off. When the damping force level is changed turn on the power supply of EDFC so that it returns to 0.

**CONFIRMATION** Sound comes out when a motor rotates but this is not unusual. When the damping force control mechanism is in totally close state a motor shaft does not rotate.

### 2. How to set the damping force level mode

- When the power supply of EDFC is turned on 16-level mode is set but the mode can be changed to 32-level mode by pushing Ft damping force control + button and Rr damping force control + button at the same time just after the zero return mode is performed.
- Even if the other operation than pushing the two buttons as above is performed 16-level mode is not changed.
- If the mode is 32-level the figure of 32 is shown at the 32-level mode display part on LCD and if there is no figure on the part the mode is 16-level.
- To change the mode, turn on the power supply of EDFC again and reset the mode.

**REF** The range of the damping force of 32-level mode and 16-level mode is same (the range between from the hardest level to the softest level). 8-level of 16-level mode is equivalent to 16-level of 32-level mode. If a driver wants to set at 8.5-level of 16-level mode he can set 17-level of 32-level mode and enjoys finer adjustment of the damping force.

### 3. How to change the damping force level

- For hardening Ft or Rr damping force, change the level to desired one by pushing the damping force control - button. To the contrary for softening it change the level to the desired one by pushing Ft or Rr damping force + button. (Level 0 is the highest or hardest damping force level).
- By pushing the button the motor rotates and the damping force level at each time is shown at the damping force level display part on LCD.
- By continuing pushing the button the level can be changed continuously.

**REF** Ft damping force and Rr damping force can not be changed simultaneously.

### 4. How to store the desired setting in memory

- EDFC is equipped with a function to store three settings of the damping forces in memory. For storing the desired setting in memory, push the memory button (P-1, P-2 and P-3) where to store for two seconds. The present Ft and Rr damping force levels are stored and the memory button is turned on red. The memory number is displayed at the memory display part on LCD and it blinks for three seconds.

 **CAUTION** Keep in mind that if the power supply of EDFC is turned off the memory is deleted. If the power supply of EDFC is continuously turned on the memory is kept.

**REF** The initially set levels of Ft and Rr are both 0.

### 5. How to recall the memory of the desired setting

- Push the button where the desired setting is stored. The motor rotates to the memorized damping force level and the level is shown at the damping force level display part on LCD. Then, the memory button blinks red and the memory number is shown at the memory number display part on LCD.

### 6. How to change the buzzer volume

- The buzzer volume can be set at four levels as loud, normal, low and silent, and by pushing the two buttons of P-1 and P-2 at the same time for two seconds the volume change mode is set.
- The volume level can be changed by pushing Rr damping force control + button or Rr damping force control - button. The changed level is shown at the buzzer volume level display part on LCD.
- By pushing the two buttons of P-1 and P-2 at the same time for two seconds controller is released from the volume change mode. (Even if it is not released manually it is automatically released canceled after 10 seconds).

 **CAUTION** Keep in mind that if the power supply of EDFC is turned off the memory is deleted. (The initially set volume is normal). If the power supply of EDFC is continuously turned on the setting is kept.

### 7. How to control the brightness of dimmer function

- The brightness of dimmer function can be set at three levels as bright, normal and dark when the lamps are turned on and the two memory buttons of P-2 and P-3 at the same time for two seconds the brightness change mode is set.
- By pushing Rr damping force control + button or Rr damping force control - button the brightness can be changed.
- By pushing the two memory buttons of P-2 and P-3 again at the same time for two seconds controller released from the mode (Even if it is released manually it is automatically released after 10 seconds).

 **CAUTION** Keep in mind that if the power supply of EDFC is turned off the memory is deleted. (The initially set brightness is normal). If the power supply of EDFC is continuously turned on the setting is kept.

### 8. In order to avoid the unnecessary operation

- Push the three buttons of P-1, P-2 and P-3 at the same time for two seconds so that the operation lock mark (KEY mark) is shown at the operation lock display part on LCD and the control box stops receiving the operation except the one for canceling the lock mode.
- For cancel the lock mode push again the above three buttons at the same time for two seconds. The lock mark on LCD disappears.

### 9. When an error mark is displayed.

- If the control box detects any trouble such as the disconnection of a motor cable, an error mark is shown on the damping force level display part on LCD. The mark is shown as follows: (Right side: ER, Left side: EL, Both sides: EE)
- If such error is shown immediately turn off the power supply of EDFC and check the wiring or motor according to the trouble-shooting after extracting a key from a key cylinder and removing the cable from the minus terminal of a battery.

 **WARNING** The circuit is designed in consideration of safety but it is very dangerous to drive a car while an error mark is displayed on LCD, which may cause such troubles as fire of wiring or fire of a car.

## Trouble-shooting

Troubl	Probable causes	Solution
Pushing the power source button but no reaction	The power supply cable is not connected securely	Confirm if the branch connector and the ground cable are securely connected. If not,
	The accessory power supply is not turned on.	Turn the key to turn on the accessory power supply.
	The connectors of the control box and the power source cable are not connected securely	Securely connect the connector.
	The fuse is cut off.	Confirm if all cables are securely connected and if so, exchange the fuse.
Turning on the light but the indications of LCD do not darken	The illumination power supply cable is not connected securely.	Find a branch connector which is not securely connected and connected it securely.
An error mark is displayed.	The wiring to the motor is disconnected.	Find a damaged or disconnected motor cable and exchange or securely connect it.
	The connector of the motor cable is not connected securely.	Securely connect the connector.
Motor would not rotate.	Some parts are deformed or damaged due to strong stress at installing.	Confirm if the motor shaft turns lightly with a minus screw driver and if not, install it again according to this manual
The controller would not correct operation.	The computer within the controller may be error operation the cause of electromagnetic wave of cellular phone or heat .	After removing the cable from the minus terminal of a battery, securely connect it and reset the controller.

## Important Notice

1. All TEIN products are off-road use (including racing) and show purposes only.
2. TEIN products should not be used in vehicles driven on public roads.
3. TEIN takes no responsibility for parts which are prohibited by local laws.
4. The installation of this product on vehicles running on public roads may be dangerous, and may violate local laws.
5. Purchaser takes full responsibility for proper part installation.
6. All parts should be installed by a properly licensed mechanic.
7. TEIN takes no responsibility for damage, injuries, or death caused directly or indirectly by this product.
8. TEIN will not take any responsibility for errors and/or omission in these installation instructions.

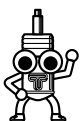

### Customer service

If you find any fault in our product or want to know further please contact us.

#### TEIN U.S.A., INC.

9798 Firestone Blvd. Downey, CA 90241

Phone(562)861-9161 / Fax(562)861-9171

URL: <http://www.tein.com> / E-mail: [sales@tein.com](mailto:sales@tein.com)